



BAKERTOP MIND.Map^s™ PLUS



Index

BAKERTOP MIND.Maps™ PLUS ovens	page	4
Baking Assistance	page	8
Technologies	page	12
PLUS capacitive control panel	page	24
BAKERTOP MIND.Maps™ PLUS COUNTERTOP	page	28
BAKERTOP MIND.Maps™ PLUS BIG	page	42
Baking Essentials Special Trays	page	50
Care and Maintenance	page	58
Technical data	page	64
Technical Assistance	page	72
Unox in the world	page	74



BAKERTOP MIND.Maps™ PLUS
BIG



BAKERTOP MIND.Maps™ PLUS
COUNTERTOP

BAKERTOP MIND.Maps™ PLUS

Intelligent combi ovens

BAKERTOP MIND.Maps™ PLUS is the intelligent combi-oven for fresh or frozen artisan pastry and bakery. Automatic baking cycles and smart functions, including artificial intelligence baking control, make BAKERTOP MIND.Maps™ PLUS the fundamental tool for your professional laboratory. In combination with the LIEVOX proofers and the DECKTOP static ovens, it allows you to create versatile and multi-function baking stations.

The MIND.Maps™ PLUS ovens are available in two versions to meet the specific need of each business:

COUNTERTOP 4, 6 and 10 trays 600 x 400 for professional laboratories;

BIG with trolleys for 16 600 x 400 trays for larger needs, like supermarkets and bakery production.

Designed by your desires

Services

Our promise is your guarantee of solid performance. Stay focused on your goals knowing that we are always by your side.



Individual Cooking Experience

Try the oven for free. It's on us



01

Book

Choose when and where to try your next Unox oven. Call our customer service and set up an appointment at your convenience.

Set up an appointment, call us or book it online on [unox.com](https://www.unox.com)



02

Cook with us

In your laboratory, with your ingredients and your recipes: a Unox Chef will make you experience all the benefits of the ovens' technologies.



03

Choose

Being sure of the results you can achieve, take the time you need to make a choice based on solid certainties.





Baking Assistance

TOP.Training

Discover your oven



Learn, use, improve

Top.Training is the Unox free training service. Our Chefs will show you everything you need to get the best from your new oven, from its basic features to its most advanced technologies.

Download the **Top.Training** app from Google Play or App Store

Data Driven Cooking Community

Inspire and be inspired



A world of Recipes for your ovens

Let yourself be inspired by the DDC.App cookbook: download the recipes prepared by the Unox Chefs and by the DDC community users. Participate in the community and share your recipe!

Download **DDC.App** from Google Play or App Store

CHEF.Line

You call, Unox answers



h 24, 7 days a week

The Unox Chef Team is always at your disposal to give you practical advice on programs baking methods and to suggest you new recipes: from the most traditional to the most innovative ones.

Call **+39 049 86 57 511**



Apple Store



Play Store

Intelligent. Precise. Connected.



Unox Intelligent Performance

A set of intelligent technologies designed to maximize your output, improve your performance and give shape to your ambitions.

Unox Intensive Cooking

The most advanced technologies to guarantee perfect baking, uniformity on every tray and maximum baking intensity.

Data Driven Cooking

Artificial intelligence which allows you to monitor your oven usage and provides you with suggestions to use the ovens in a better way.

Unox Intelligent Performance

Improve your performances

Achieving identical results for each load requires control, intelligence and expertise: exactly what BAKERTOP MIND.Maps™ PLUS combi oven is made for.

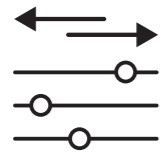

ADAPTIVE.Cooking™

Perfect results. Every time.

By registering changes in humidity and temperature, the oven automatically adjusts the baking process to the actual food-load to deliver an identical and perfect result every time.

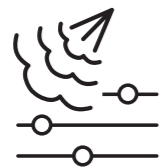

CLIMALUX™

Total humidity control.

The oven features accurate sensors to measure the actual humidity inside the baking chamber and automatically activates steam production or evacuation to ensure that actual humidity always matches the set one.

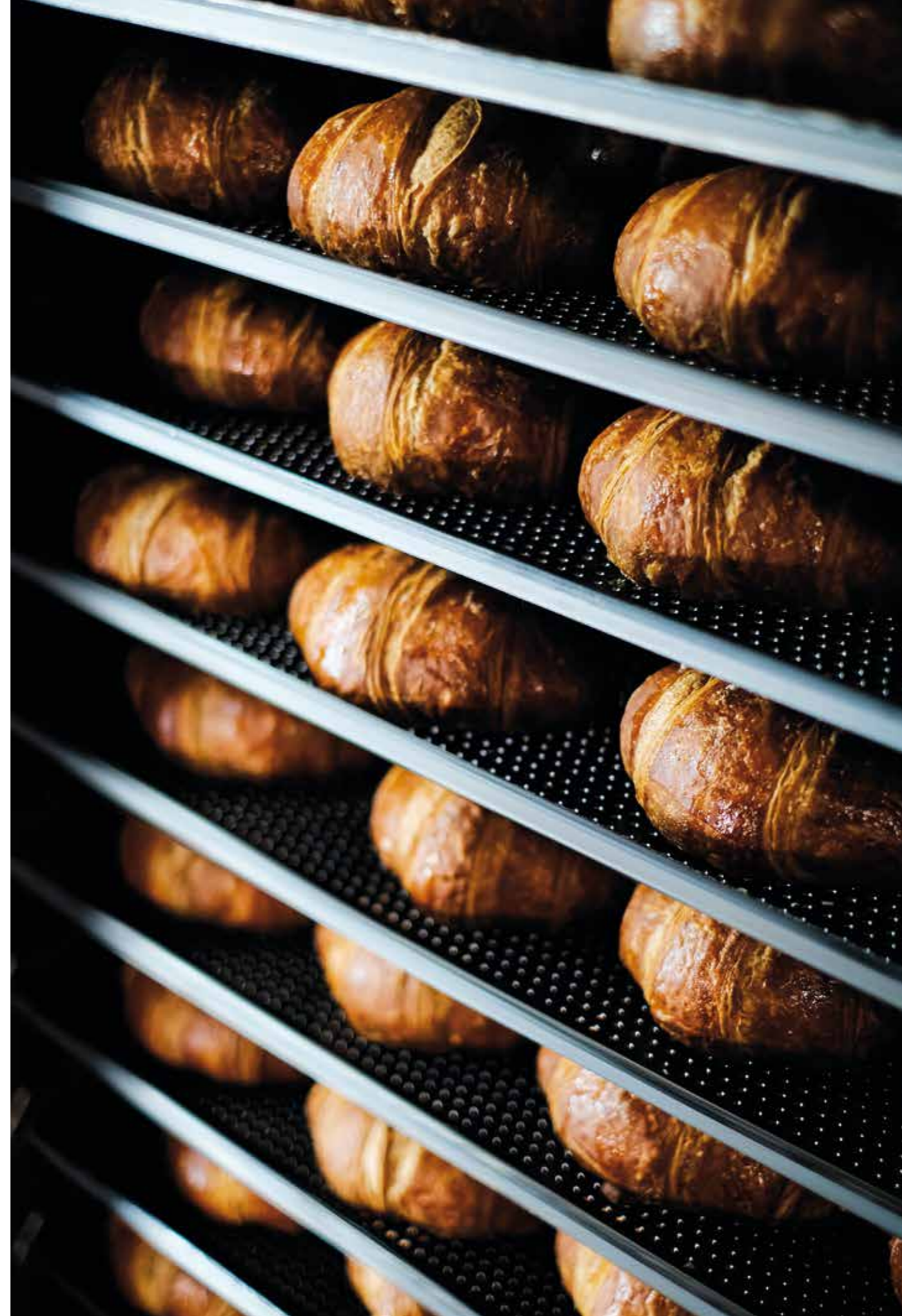

SMART.Preheating

Intelligent preheating.

Combining the analysis of previous baking processes with the requirements of the next one, the oven automatically sets the best temperature and preheating time to guarantee maximum repeatability of results throughout the day, therefore reducing waiting time.



AUTO.Soft

Gentle baking function.

When activated, the oven automatically regulates the rise in temperature to make it gentler and guarantee an optimal heat distribution on each pan in the oven. The best for delicate and heat-sensitive foods.



SENSE.Clean

Intelligent cleaning.

By estimating the degree of dirtiness, based on the type of baking recognised by the oven, it suggests the best automatic cleaning mode according to the actual use of the oven. Maximum hygiene and zero waste of water and detergent.

With

Adaptive.Cooking™

It sets automatically all baking parameters to guarantee the same result for every process.

Without

Optimal settings for a half load - 9 cake tins

🕒 20 mins

🌡️ 155 °C

💧 0%

Half load setting used with a single tray or with a full load.

Single tray - 3 cake tins



Perfectly cooked

Even shape and surface
Dry, but remains moist inside

Time
18 mins
Average temperature
150 °C
Humidity
0 %



Too much heating

Burned thick crust
Too dry inside

Time
20 mins
Average temperature
185 °C
Humidity
0 %

Full load - 36 cake tins



Perfectly cooked

Even shape and surface
Dry, but remains moist inside

Time
23 mins
Average temperature
165 °C
Humidity
0 %



Not enough cooked

Pale colour
Collapsed structure

Time
20 mins
Average temperature
155 °C
Humidity
50 %

With

CLIMALUX™

Measures the actual humidity in the baking chamber and produces or extracts the quantity of humidity needed to obtain the set one.

Without

* Optimal settings for a half load - 60 mini baguettes

🕒 18 mins

🌡️ 185 °C

💧 30%

Half load setting used with a single tray or with a full load.

Single tray - 20 mini baguettes



Perfect browning

Browned crust
Dry crumb
Crunchy texture

Humidity
30 %



Burned bread

Dark colour outside
Not developed inside
Bitter taste

Humidity
10 %

Full load - 120 mini baguettes



Perfect browning

Browned crust
Dry crumb
Crunchy texture

Humidity
30 %



Not enough browning

Moist inside
Pale browning
No crunchiness

Humidity
80 %

With

Auto.Soft

It manages the rise in temperature and maintains uniformity in every point of the tray, in each tray.

Without

*

Optimal settings for a half load

	5 mins	15 mins
	135 °C	175 °C
	30%	- 50%

Half load setting used with a single tray or with a full load.

Single tray



Perfectly cooked

Browned outside
Dry and empty inside
Total uniformity

Rise time 135 °C - 175 °C
4 mins



Ruined baking

Burned edges
Uneven baking
Not developed choux pastry

Rise time 135 °C - 175 °C
1 min

Full load



Perfectly cooked

Browned outside
Dry and empty inside
Total uniformity

Rise time 135 °C - 175 °C
7 mins



Ruined baking

Burned edges
Uneven baking
Not developed choux pastry

Rise time 135 °C - 175 °C
3 mins



With



SMART.Preheating

The Intelligence automatically regulates duration and intensity of preheating: intense when the oven is cold, fast or even skipped when the oven is already hot.

Without

*

Optimal settings for a half load

PRE	190 °C
	18 mins
	165 °C

Half load setting used with a single tray or with a full load.

Single tray



Cold oven

Perfect browning

Perfectly alveolar inside

Preheating time
9 mins
Temp. oven chamber steel
165 °C



Hot oven

Perfect browning

Perfectly alveolar inside

Preheating time
20 sec
Temp. oven chamber steel
165 °C



Cold oven

Pale browning

Raw inside

Preheating time
6 mins
Temp. oven chamber steel
100 °C



Hot oven

Extreme browning

Burned outside

Preheating time
6 mins
Temp. oven chamber steel
190 °C

Full load



Cold oven

Perfect browning

Perfectly alveolar inside

Preheating time
9 mins
Temp. oven chamber steel
165 °C



Hot oven

Perfect browning

Perfectly alveolar inside

Preheating time
20 sec
Temp. oven chamber steel
165 °C



Cold oven

Pale browning

Raw inside

Preheating time
6 mins
Temp. oven chamber steel
100 °C



Hot oven

Extreme browning

Burned outside

Preheating time
6 mins
Temp. oven chamber steel
190 °C

Unox Intensive Cooking

Maximum baking intensity

Perfect baking, uniformity on each tray, saturated and dense steam or complete extraction of humidity, intense or gentle air flows.

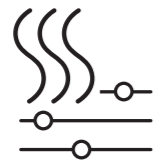

DRY.Maxi™

Humidity gives way to flavour.
Effectively removes humidity from the baking chamber to give your preparations perfect consistency, colour and crunchiness every time.



STEAM.Maxi™

The power of steam is in your hands.
Generates saturated steam from 35 °C and delivers high steaming performance combined with energy and water savings.

16 minutes

full load of **croissants**

18 minutes

full load of **baguettes**

25 minutes

full load of **choux pastry**

45 minutes

full load of **panettone cakes**

20 minutes

full load of **puff pastry**

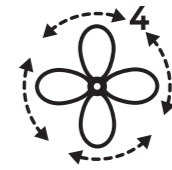

AIR.Maxi™

Conducts, unites, transforms.
Uses multiple high flow reversing fans to deliver uniform results and short baking times. 4 speeds of the fan allow to perform any kind of baking.



EFFICIENT.Power

Power and efficiency.
Quick temperature rise, high-precision temperature control, ENERGY STAR certified efficiency at the top of the category in combi, dry air and steam modes.



PRESSURE.Steam

Even more steam when you need it.
Increases steam temperature and its saturation to effectively allow you to further reduce steaming time and its intensity.



Data Driven Cooking

**Create.
Understand.
Improve.**

The Data Driven Cooking Artificial Intelligence transforms the consumption data of your oven into useful information that allows you to increase your daily profit.

Data will be always accessible by smartphone or PC

An ecosystem to be discovered



Create and share

Your recipes in all your ovens.
Create your recipe book and synchronize it with all your ovens with just one click, keeping all your kitchens or stores up to date. You may create it directly from one of your ovens or from your PC.



Understand

Monitor and improve your performance.
DDC.Stats gives you full control over energy, water, and detergent consumption and over your baking times and oven usage. Compare the performances, detect anomalies and get useful information to improve the efficiency of the ovens in your network.

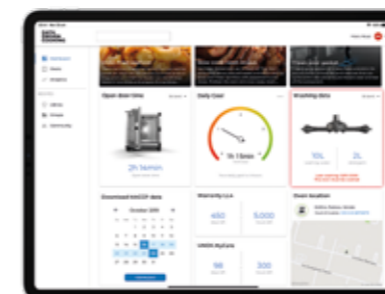

360° Assistance

Let DDC.Coach train you.
DDC.Coach is a digital assistant that provides you with advice based on the actual use of your ovens. This allows you to take full advantage of their potential. Capitalize the abilities of your ovens and maximize the return on your investment!



PLUS capacitive control panel

Comprehensive and intuitive

Automatic cooking processes, manual functions, 384 programs memory and up to 10 simultaneous cooking. A large, readable touchscreen, that is fast and connected.



Outdo yourself



SET

Easy, fast and crystal-clear.

Set any baking process in a rapid and intuitive way for each of the available baking steps. All the settings you need in a single screen, up to 9 baking steps. Limitless creativity.



MIND.Maps™

Do not set a baking process, draw it.

Add your touch of brilliance. Draw even the most elaborate baking with a few hand gestures on the display. Design your most complex baking processes with maximum creative freedom. You imagine, the oven executes.

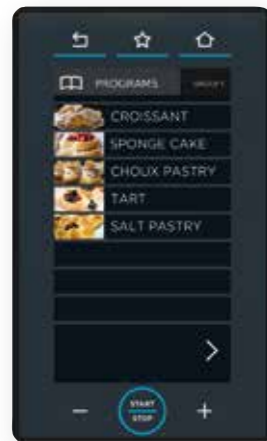

PROGRAMS

384 Programs memory.

All your recipes are unique and repeatable thanks to the personal library that allows you to store and organize your baking programs. BAKERTOP MIND.Maps™ PLUS can store 384 programs organized in 16 different groups.



MULTI.Time

Up to 10 simultaneous baking.

Ordered and organized. Manage up to 10 baking processes at the same time with the MULTI.Time function and have the maximum control with a quick glance.



CHEFUNOX

Choose what you want to bake and the desired result.

Trust and allow your oven to set the baking parameters for you. Select the type of baking, the food you want to bake and the degree of baking you want. Start. Nothing else.



MISE.EN.PLACE

Beyond kitchen organization.

Suggests the correct order and timing for inserting trays inside the baking chamber to have all the meals ready at the same time. Being punctual has never been so simple.

BAKERTOP

BAKERTOP MIND.Maps™ PLUS COUNTERTOP

Intelligent combi ovens for Confectionery and Bakery

BAKERTOP MIND.Maps™ **PLUS** COUNTERTOP is the point of reference for every professional laboratory that needs maximum performance, intelligent technologies and versatility without limits.



Dream big

Express your creativity

BAKERTOP MIND.Maps™ PLUS COUNTERTOP is the professional baking oven that cancels any distance between your ideas and their realization. Discover the pleasure of baking perfection.

Combined with its accessories, BAKERTOP MIND.Maps™ PLUS COUNTERTOP becomes a fully equipped, 1-square-meter baking station, where convection and static baking, combi baking and proofing is all possible.

Baking of leavened products, artisan or frozen pastry, dehydration, biscuits and much more. Automatic baking cycles and intelligent functions for impeccable results.

5 mins

Preheating **time**
from 30 °C to 260 °C

up to 80%

Less water compared to
cooking in boiling water

up to 45%

Faster than a traditional
or convection oven

Data refers to XEBC-06EU-EPRM



Baking Perfection
Consistent and
outstanding results

Uniformity
Even colour, developed
internal structure

Savings
Energy, time,
ingredients and labor

Intelligence
Focus on your customers,
the oven will do the rest

Versatile solutions for your individual needs

Increase your Possibilities

Find all the possible solutions for your professional laboratory.
Configure your BAKERTOP MIND.Maps™ PLUS oven online.
www.unox.com/en_ae/configurator



Configurations



Solution Oven + Neutral Cabinet

Recommended solution to optimize the space inside your laboratory and always have everything in order.

Art. XWAEC-08EF
Technical details at page 70



Solution Oven + Oven

Two stacked ovens provide maximum versatility and flexibility combined with energy saving.



Solution Oven + Decktop + Lievox

A limitless baking station: leavening, traditional baking on stone, convection baking and combi baking.

Art. XEBDC-01EU-C and XEBPC-08EU-B
More informations at page 36
Technical details at page 70



Solution Oven + Oven + Lievox

Versatility and efficiency with two stacked ovens combined with perfect proofing. Ideal for in-store baking.

Art. XEBPC-08EU-B
More informations at page 37
Technical details at page 70

Configurations

COUNTERTOP

COUNTERTOP

Install your oven where you need it

Ventless Hood

Within the ventless hood, a self-cleaning filter **removes odours** from the fumes that are expelled through the oven chimney, without the need for maintenance or cleaning work on the filter. It allows you to install your oven even far from a ceiling canopy and force exhausts into it or outside.*

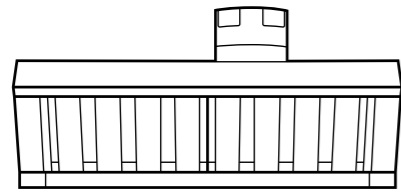

* Subject to inspection and approval by organisations and to local regulations.



Without using water

Waterless Hood

The waterless hood filters odors and absorbs latent heat from the exhausts pipes **without using water**. Elegant and functional, it perfectly integrates into any store design with no need of water supply or drainage.*

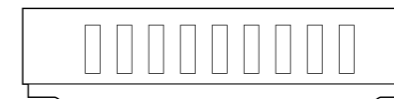

* Subject to inspection and approval by organisations and to local regulations.

The modern Static oven

DECKTOP

Traditional stone baking of bread, buns or leavened products: just one of the possibilities that DECKTOP offers. Thanks to the possibility to introduce or extract humidity during the baking cycle, it makes your baking perfect with any load: soft or fragrant; soft or crunchy. Oven, DECKTOP and prover, give life to an extremely versatile and limitless baking station.

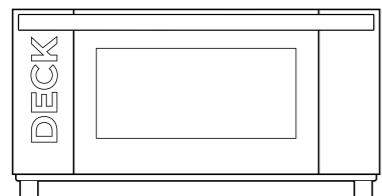

Everything starts with a correct leavening

LIEVOX

Leavening is a game of balance between dough, temperature, humidity and time. LIEVOX proofers are equipped with capable sensors to control and **intervene automatically on the leavening process** to guarantee the quality of the final product. LIEVOX opens a world of possibilities in baking traditional products such as bread, leavened cakes, croissants and much more.

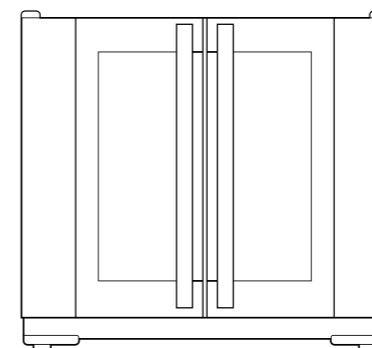

Steam Explosion

STEAM.Boost

STEAM.Boost is a high capacity heat storage system that allows your oven to produce, if required, **50% more steam** during the crucial minutes of the starting of the baking process. STEAM.Boost is a fundamental accessory for all artisan laboratories that want to use modern technologies in full compliance of the centenary tradition of baking.

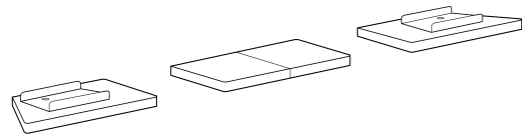

Effortless loading, unloading and transportation

QUICK.LOAD



Complementary Accessories

Complementary Accessories

Door or Doorless 6 + 6 QUICK.Load

Mobile trolley, basket and accessories to easily load, unload and transport 6 + 6 trays of dough.

Art. XWBYC-12EU and XWBYC-12EU-D
Technical details at page 71

6 + 6 Solution with stand

Up to 12 trays baking.

4 + 10 Solution with stand

Up to 14 trays baking.

Door or Doorless 10 + 4 QUICK.Load

Mobile trolley, basket and accessories to easily load, unload and transport 4+10 trays of dough.

Art. XWBYC-14EU and XWBYC-14EU-D
Technical details at page 71

COUNTERTOP

COUNTERTOP

BAKERTOP MIND.Maps™ PLUS BIG

**Stronger
Harder
Faster
Better**

The BAKERTOP MIND.Maps™ PLUS BIG trolley oven is the tireless tool for large pastry shops and bakeries, which require maximum repeatability and high productivity.



All that matter

Limitless performances

BAKERTOP MIND.Maps™ PLUS BIG is the professional trolley oven that guarantees high productivity and reliability over time.

BAKERTOP MIND.Maps™ PLUS BIG exploits the latest technologies to give concrete support to your work.

Baking quality and uniformity with every load, in every point of the pan, on all the pans. The repeatability of the baking result is delivered independently by the operator. Safe, error-free actions and with minimal effort.

768 croissants

60 mins **productivity**
1 croissant = 85 gr

300 °C

Maximum cooking **temperature**

up to **30%**

Less **energy** compared to a rotary oven

Data refers to XEBL-16EU-YPRS



Productivity
High volumes,
zero stops

Uniformity
6 close-pitch
reversing fans

Repeatability
Standardized results,
consistency

Intelligence
Focus on your customers,
the oven will do the rest

What lies behind?

Built to last

Space-frame chassis

The BAKERTOP MIND.Maps™ PLUS BIC features a **space-frame chassis** made of 50 mm thick **stainless steel tubes**. The whole structure is extremely rigid and the door is fixed to the frame to guarantee its perfect closure even after years of work.



Door with push-to-close function

Tested for over 1 million cycles, the **push-to-close** function of the door **reduces** the operator **efforts** during work. The door strength and security are guaranteed by **70 mm** thickness.

316L Stainless steel

The baking chamber and the trolley are made of **316L stainless steel**, which guarantees **resistance** over time **to any type of corrosion**. PURE-RO water treatment for chloride elimination is not necessary, the PURE treatment is required for the removal of limestone from water.

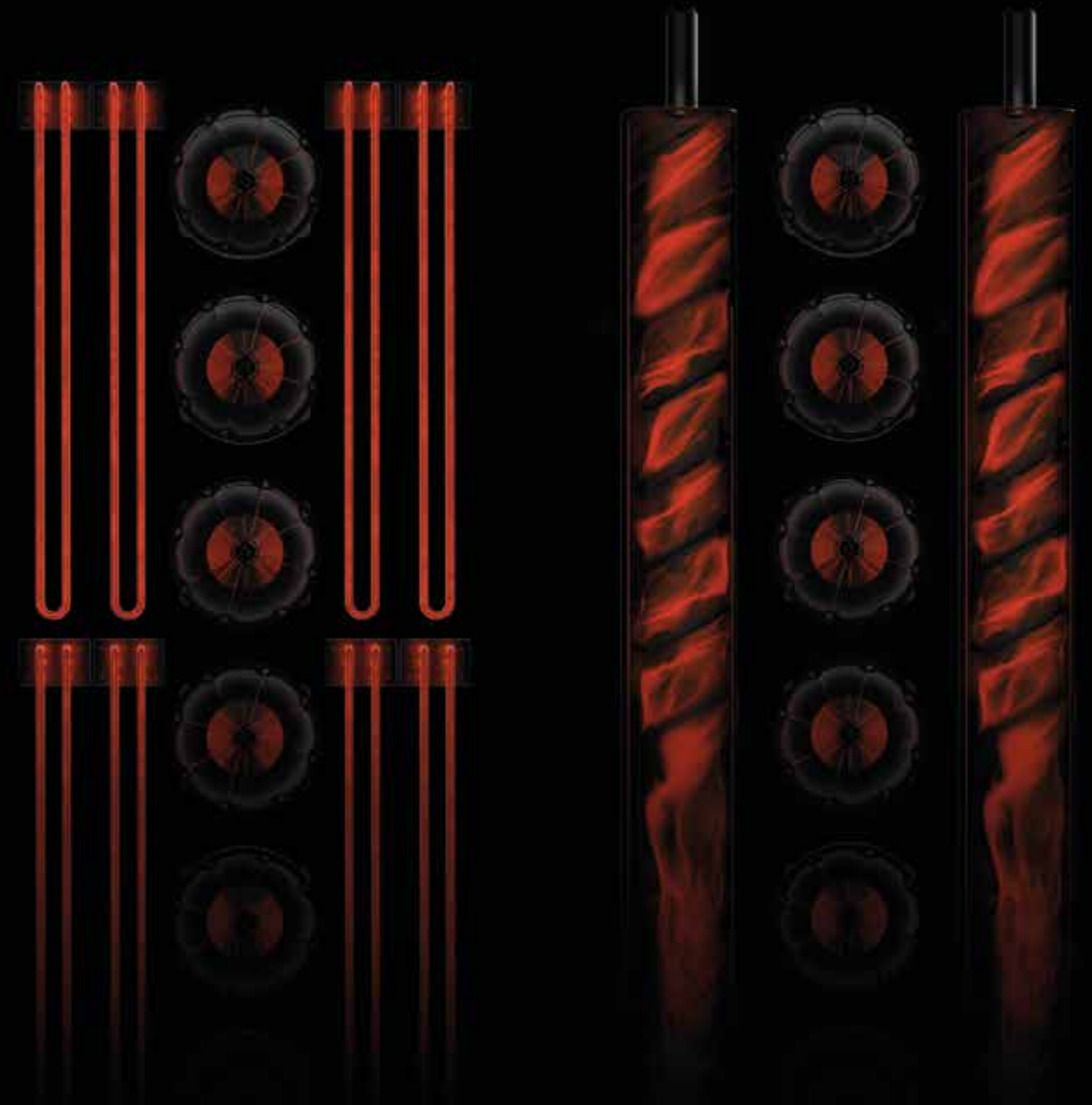

Symmetric Perfection

6 close-pitch reversing fans

High-performance heating elements

Electric ovens feature unique **straight-line heating elements** with high power intensity that produce heat quickly, minimizing temperature recovery times and optimizing air flows.

Pressure gas burners

Unox gas ovens are the only ones in the world with high performance blown burners and **symmetrical straight heat exchangers**. High power minimizes temperature recovery times and air flows.

Solutions that maximize your investment

Maximum Yield, minimum effort

Solutions

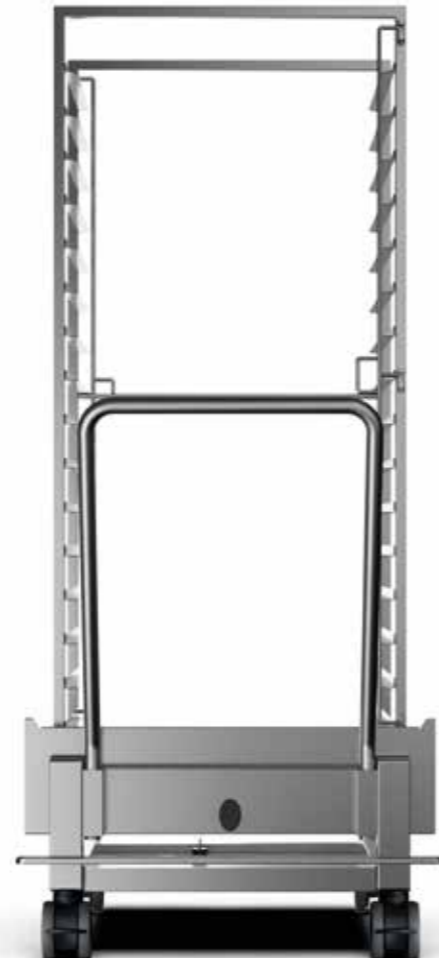

QUICK.Load

16 600x400 trays trolley makes loading, unloading and transport easy, quick and convenient.

Art. XEBTL-16EU
Technical details at page 71

Find all the possible solutions for your professional laboratory.
[Configure](#) your BAKERTOP MIND.Maps™ PLUS oven online.
www.unox.com/en_ae/configuratore





Baking Essentials trays and pans

Limitless baking

The perfect tray for each baking

Baking Essentials

BAKE

Aluminium tray.



PASTRY AND BAKERY

Ideal for

Pastry;
Cakes;
Baking on silicon mats.

Advantages

Aluminium tray for rapid heat exchange;
Ultra low edge for maximum baking
uniformity.

Art. TG405 600 x 400

FORO.BAKE

Perforated aluminium tray



PASTRY AND BAKERY

Ideal for

Pastry;
Cakes.

Advantages

Perforated aluminium tray to increase
the dough sweating during baking;
Ultra low edge for maximum baking
uniformity.

Art. TG410 600 x 400

BAKE.BLACK

Non-stick aluminium pan.



PASTRY AND BAKERY

Ideal for

Croissant;
Danish pastries;
Pastry.

Advantages

Rapid heat exchange;
Baking paper not necessary;
Ultra low edge for maximum baking
uniformity.

Art. TG460 600 x 400

FORO.BLACK

Non-stick perforated aluminium pan.



PASTRY AND BAKERY

Ideal for

Croissants;
Frozen bread;
Danish pastries and pastry.

Advantages

Ultra low edge for maximum distribution
of air flows;
Baking paper not necessary.

Art. TG430 600 x 400

The perfect tray for each baking

Baking Essentials

BAKE.SILICO

Silicon coated aluminium pan.



PASTRY AND BAKERY

Ideal for
Croissants;
Frozen bread;
Danish pastries and pastry.

Advantages
High-temperature resistant silicon-coated aluminium pan;
Ideal for sugar coated products.

Art. TG416 600 x 400

FORO.SILICO

Perforated silicon coated aluminium pan.

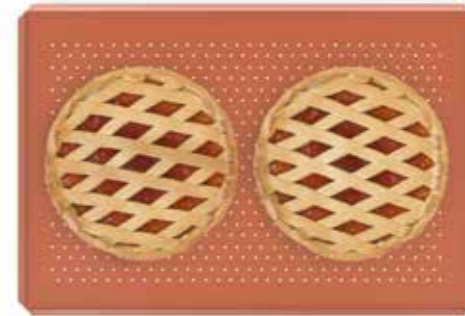

PASTRY AND BAKERY

Ideal for
Croissants;
Frozen bread;
Danish pastries and pastry.

Advantages
High-temperature resistant silicon-coated aluminium pan;
Ideal for sugar coated products.

Art. TG415 600 x 400

FAKIRO™

Aluminium pan. Two surfaces - flat and ribbed - for different products.



PASTRY AND BAKERY

Ideal for
Pizza;
Focaccia;
Bread.

Advantages
High-thickness aluminium pan with stone baked effect;
Flat surface to cook fresh products;
Ribbed surface to cook frozen products;

Art. TG440 600 x 400

FAKIRO.GRILL

Non-stick aluminium pan. Two surfaces - flat and ribbed - for different bakings.

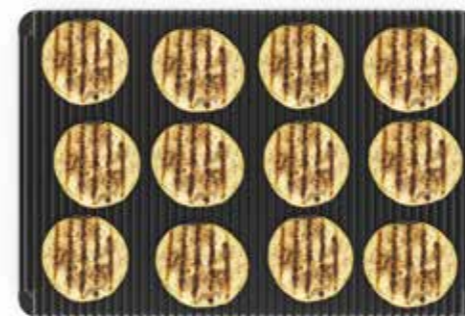

PASTRY AND BAKERY

Ideal for
Grilled meat, fish or vegetables;
Pizza;
Focaccia.

Advantages
High-thickness aluminium pan with stone baked effect;
Flat surface to cook fresh bakery products
Ribbed surface to grill different food.

Art. TG465 600 x 400

The perfect tray for each baking

Baking Essentials

FORO.BAGUETTE

Perforated aluminium tray - 5 channels.



PASTRY AND BAKERY

Ideal for

Frozen baguettes;
Frozen midi-baguettes.

Advantages

Baguettes that are baked uniformly
and separately;
Ideal for frozen products.

Art. TG445 600 x 400

FORO.BAGUETTE.BLACK

Non-stick perforated aluminium tray
- 5 channels.



PASTRY AND BAKERY

Ideal for

Fresh baguettes;
Fresh midi-baguettes.

Advantages

Baguettes that are baked uniformly
and separately;
Ideal for fresh dough and for ultra-fast cleaning

Art. TG435 600 x 400

STEEL.BAKE

Stainless steel pan.



PASTRY AND BAKERY

Ideal for

Sponge cake;
Cigarettes Russes.

Advantages

Steel tray with 90° Corners for no waste;
Anti-buckling double edges.

Art. TG450 600 x 400

BAGUETTE.GRID

Extra-light chromium plated grid - 5 channels.

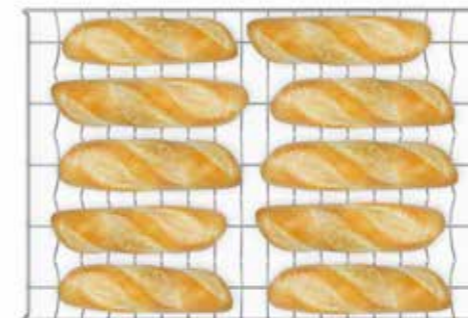

PASTRY AND BAKERY

Ideal for

Frozen baguettes;
Frozen midi-baguettes.

Advantages

Maximizes the air circulation on every surface
of the bread.

Art. GRP410 600 x 400

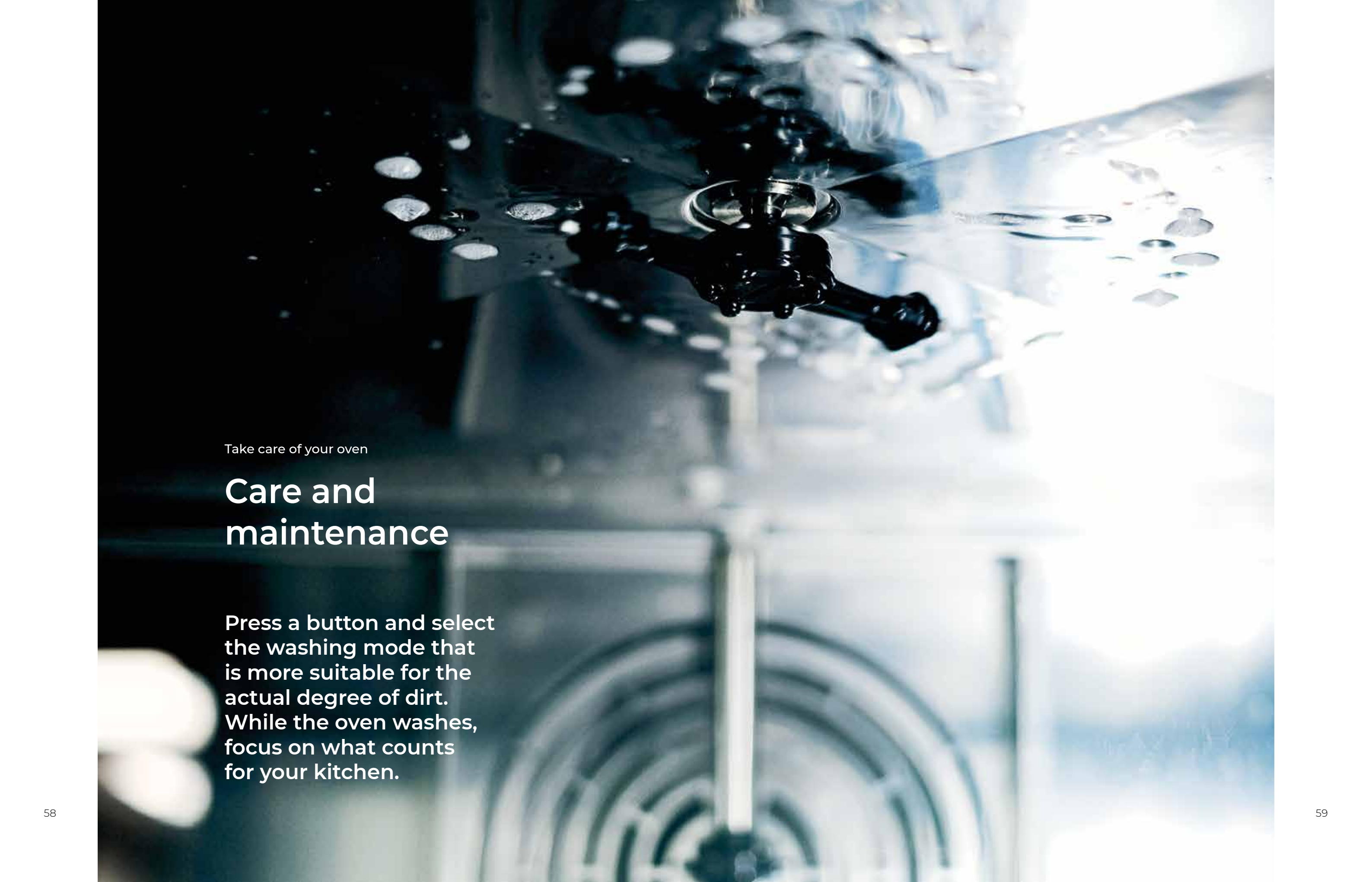
A close-up, low-angle shot of the interior of a stainless steel oven. A black spray nozzle is positioned in the center, with water droplets falling from it. The background shows the circular vents of the oven's interior, which are slightly out of focus. The lighting is bright, creating a clean and modern aesthetic.

Take care of your oven

Care and maintenance

Press a button and select the washing mode that is more suitable for the actual degree of dirt. While the oven washes, focus on what counts for your kitchen.

UNOX.Pure

DET&Rinse™

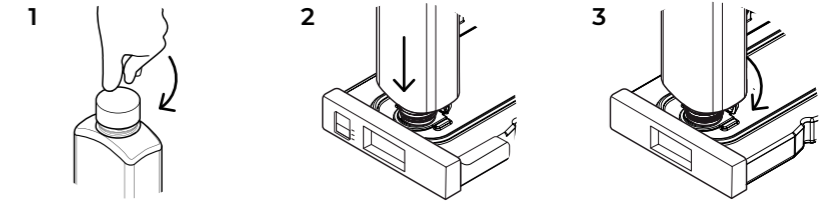

PURE-RO

Reverse osmosis system that reduces the carbonate hardness of water to zero, thus avoiding any scale deposits inside the oven.

Art. XHC002
Technical details at page 69

Not required for BAKERTOP
MIND.Maps™ BIG ovens.



PURE

The UNOX.Pure filter reduces the carbonate hardness in water, thus avoiding scale deposits inside the oven cooking chamber.

Art. XHC003
Technical details at page 69



REFILL

Replacement cartridge for UNOX.Pure.

Art. XHC004
Technical details at page 69



PLUS

Cleaning and rinse agents to combine maximum cleanliness with minimum consumption and long life for your oven.

Art. DB1015
Technical details at page 69



ECO

Eco formula for daily cleaning and the utmost respect for the environment. Ideal for mild level of dirt.

Art. DB1018
Technical details at page 69



ULTRA

Ultra strong detergent for high level of dirt, recommended for poultry and meat fats.

Art. DB1050*
Technical details at page 69

* Check the product availability for your Country.

Discover all the ovens and their combined accessories

The smartest ovens in the world

BAKERTOP MIND.Maps™ PLUS

COUNTERTOP

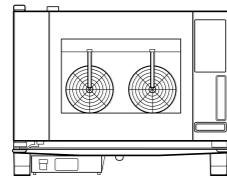

860 x 967 x 675 mm
w x d x h

⚡ XEBC - 04EU - EPRM

capacity 4 600 x 400
pitch 80 mm
frequency 50/60 Hz
voltage 400 V ~ 3N

power 10,6 kW
weight 95 kg

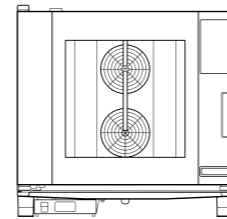

860 x 967 x 843 mm
w x d x h

⚡ XEBC - 06EU - EPRM

capacity 6 600 x 400
pitch 80 mm
frequency 50/60 Hz
voltage 400 V ~ 3N

power 14 kW
weight 112 kg

🔥 XEBC - 06EU - GPRM

capacity 6 600 x 400
pitch 80 mm
frequency 50/60 Hz
voltage 230 V ~ 1N
power 1 kW
max. gas G20, G25, G25.1,
G30, G31: 19 kW
weight 126 kg

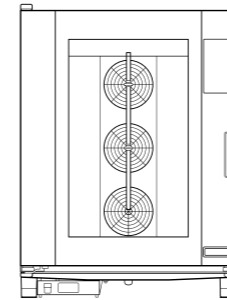

860 x 967 x 1163 mm
w x d x h

⚡ XEBC - 10EU - EPRM

capacity 10 600 x 400
pitch 80 mm
frequency 50/60 Hz
voltage 400 V ~ 3N

power 21 kW
weight 148 kg

🔥 XEBC - 10EU - GPRM

capacity 10 600 x 400
pitch 80 mm
frequency 50/60 Hz
voltage 230 V ~ 1N
power 1,4 kW
max. gas G20, G25, G25.1,
G30, G31: 25 kW
weight 163 kg

BIG

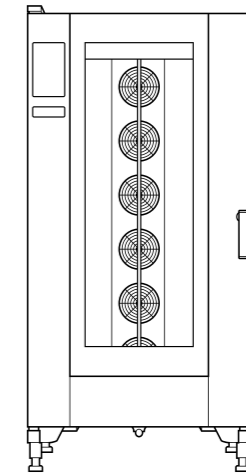

892 x 1018 x 1875 mm
w x d x h

⚡ XEBL - 16EU - YPRS

capacity 16 600 x 400
pitch 80 mm
frequency 50 / Hz
voltage 380-415 V
3PH+N+PE

power 38,5 kW
weight 292 kg

⚡ XEBL - 16EU - DPRS

capacity 16 600 x 400
pitch 80 mm
frequency 50 / Hz
voltage 220-240 V
3PH+PE

power 38,5 kW
weight 292 kg

🔥 XEBL - 16EU - GPRS

capacity 16 600 x 400
pitch 80 mm
frequency 50/60 Hz
voltage 220-240V
1PH+N+PE

power 2,8 kW
max. gas 48 kW
rated power
weight 309 kg

Technical details



Anti condensation drip tray



Integrated WiFi



MULTI.point and SOUS Vide core probe



Integrated LED light

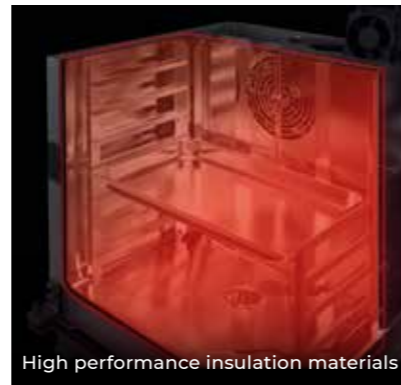

High performance insulation materials



COUNTERTOP

4 speed multiple fan system with high performance heating elements



Pressure burners with symmetrical heat exchangers



BIG

6 close-pitch reversing fans and straight-line heating elements with high power intensity

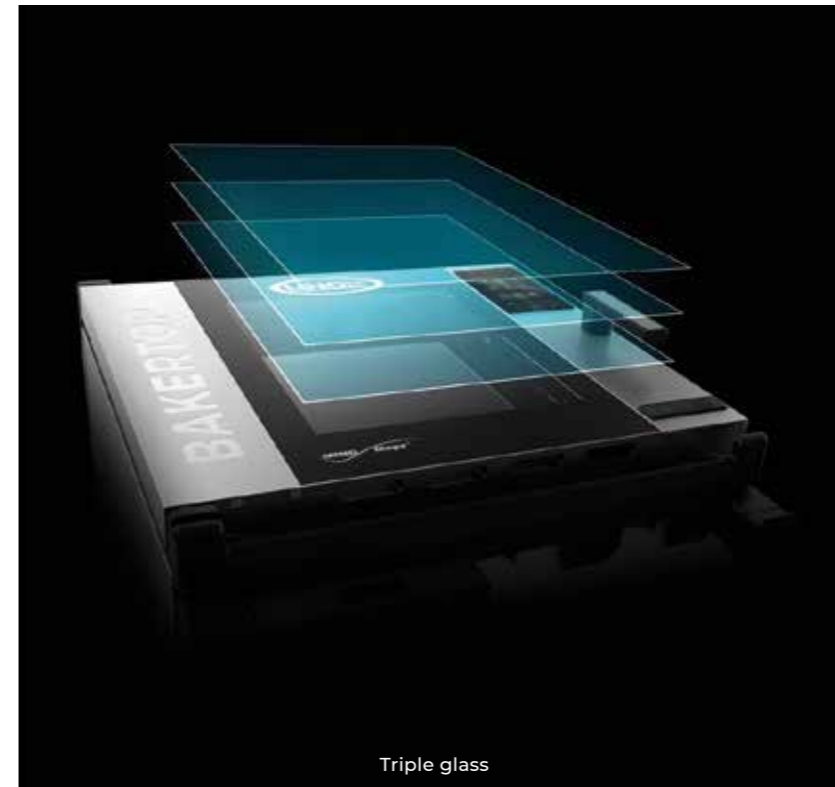

Triple glass



Integrated DET&Rinse™ tank

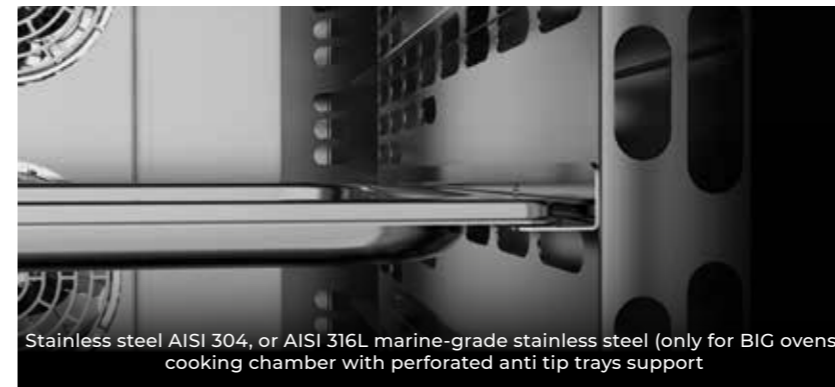

Stainless steel AISI 304, or AISI 316L marine-grade stainless steel (only for BIG ovens) cooking chamber with perforated anti tip trays support



Door docking position at 60°/120°/180°



USB port for upload/download of data



BIG Ergonomic handle

COUNTERTOP Ergonomic handle

Features

- Standard
- Optional
- Not available

BIG
COUNTERTOP

⚡ 🔥
⚡ 🔥

	BIG	COUNTERTOP
UNOX INTELLIGENT PERFORMANCE		
ADAPTIVE.Cooking™: automatically regulates the baking parameters to ensure repeatable results	●	●
CLIMALUX™: total control of the humidity in the baking chamber	●	●
SMART.Preheating: sets automatically the temperature and the duration of the preheating	●	●
AUTO.Soft: manages the heat rise to make it more delicate	●	●
SENSE.Klean: estimates how dirty the oven is and suggests appropriate automatic cleaning	●	●
UNOX INTENSIVE COOKING		
DRY.Maxi™: rapidly extracts the humidity from the baking chamber	●	●
STEAM.Maxi™: produces saturated steam starting from 35 °C	●	●
AIR.Maxi™: multiple fans with reverse gear and 4 speed settings	●	●
EFFICIENT.Power: ENERGY STAR certified energy efficiency	●	●
PRESSURE.Steam: increases the saturation and temperature of steam	●	●
DATA DRIVEN COOKING		
WiFi connection	●	●
Ethernet connection	○	○
ddc.unox.com: control the oven usage in real time, create and send recipes from your PC to your ovens	●	●
DDC.Stats: analyse, compare and improve the user and consumption data of your oven	●	●
DDC.App: monitor all connected ovens in real time from your smartphone	●	●
DDC.Coach: analyses the way in which you use the oven and suggests personalised recipes	●	●
MANUAL BAKING		
Convection baking from 30 °C to 260 °C	●	●
Convection baking from 30 °C to 300 °C	●	—
Mixed convection + steam baking starting from 35 °C with STEAM.Maxi™ from 30% to 90%	●	●
Convection + humidity baking starting from 48 °C with STEAM.Maxi™ from 10% to 20%	●	●
Saturated steam baking starting from 48 °C to 130 °C with STEAM.Maxi™ 100%	●	●
Convection baking + forced humidity extraction from 30 °C with DRY.Maxi™ from 10% to 100%	●	●
baking with core probe and DELTA T function	●	●
Single-point core probe	—	—
MULTI.Point core probe	●	●
SOUS-VIDE core probe	○	○
ADVANCED AND AUTOMATIC BAKING		
MIND.Maps™: draw the baking processes directly on the display	●	●
PROGRAMS: up to 384 programmes that can be saved with name, picture or handwritten signature	●	●
CHEFUNOX: choose something to cook from the library and the oven will automatically set all the parameters	●	●
MULTI.Time: manages up to 10 baking processes at the same time	●	●
MISE.EN.PLACE: synchronises the insertion of pans so that all the dishes are ready at the same time	●	●
AUTOMATIC CLEANING		
Rotor.KLEAN™: 4 automatic cleaning programmes	●	●
Rotor.KLEAN™: water and detergent level detector	●	●
Integrated DET&Rinse™ detergent container	●	●
AUXILIARY FUNCTIONS		
Preheating up to 300 °C can be set by the user for each programme	●	—
Preheating up to 260 °C can be set by the user for each programme	●	●
Remaining baking time display	●	●
Holding baking mode "HOLD" and continuous functioning "INF"	●	●
Display of the nominal value of the baking parameters	●	●
Temperature units in °C or °F	●	●
PERFORMANCE AND SAFETY		
Protek.SAFE™: automatic fan stop on opening the door	●	●
Protek.SAFE™: power modulation of electricity or gas depending on actual need	●	●
Spido.GAS™: high-performance straight heat exchanger pipes for symmetrical heat distribution	—	●
Spido.GAS™: high-performance pressure burners and symmetrical exchangers	—	●
TECHNICAL DETAILS		
Baking chamber in high-resistance AISI 304 stainless steel with rounded edges	—	●
Moulded baking chamber in AISI 316 L marine stainless steel	●	—
Baking chamber with L-shaped rack rails	●	●
Baking chamber lighting through LED lights embedded in the door	●	●
9.5" touchscreen capacitive control panel	●	●
7" touchscreen resistive control panel	—	—
Control panel with water resistance certification - IPX5	●	●
Drip collection system integrated in the door and functional even with the door open	●	●
Removable drip tray that can be connected to the drain	●	●
Heavy-duty structure with the use of innovative materials	●	●
4-speed multiple fan system and high-performance circular resistance	—	●
6 motors with multiple fan system with reverse gear and high power intensity rectilinear resistance	●	—
Door hinges made of high-resistance, self-lubricating techno-polymer	●	●
Door stop positions 120° - 180°	●	—
Door stop positions 60° - 120° - 180°	—	●
Reversible door in use even after installation	—	○
Door thickness 70 mm	●	—
Detachable internal glass door for ease of cleaning	●	●
Two-stage safety door opening / closure	●	○
Proximity door contact switch	●	●
Self-diagnosis system to detect problems or breakdowns	●	●
Safety temperature switch	●	●

Accessories

Discover all the available accessories on our website
www.unox.com/en_ae/accessories



HOODS

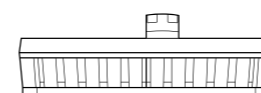

VENTLESS HOOD
for 600 x 400 BIG ovens
892 x 1131 x 342 mm - w x d x h
Art. XEAHL-HCFL



ACTIVATED CARBONFILTER
for ventless hoods
413 x 655 x 108 mm - w x d x h
Art: XUC140

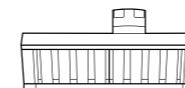

VENTLESS HOOD
for 600 x 400 COUNTERTOP ovens
860 x 1145 x 240 mm - w x d x h
Art. XEBHC-HCEU



CARTRIDGE
for activated carbonfilter
Art: XUC141



WATERLESS HOOD
for 600 x 400 COUNTERTOP ovens
860 x 1000 x 217 mm - w x d x h
Art. XEBHC-ACEU

CARE AND MAINTENANCE

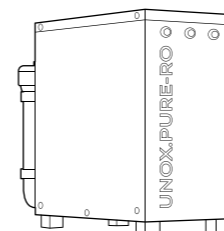

UNOX.PURE-RO
reverse osmosis filtering system
230 x 540 x 445 mm - w x d x h
Art. XHC002

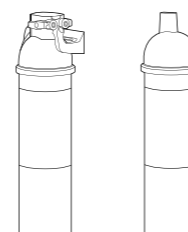

UNOX.PURE
water treatment with resin filters
Art. XHC003
+ REFILL FILTER CARTRIDGE
Art. XHC004

OVEN CLEANING PRODUCTS



DET&RINSE™ PLUS
DET&RINSE™ ECO
DET&RINSE™ ULTRA
one box contains 10 x 1 lt tanks
Art. DB1015
Art. DB1018
Art. DB1050

DECKTOP

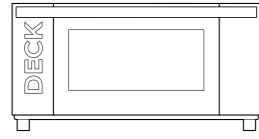

DECKTOP 2 TRAYS

with integrated control
860 x 1150 x 400 mm - w x d x h
Art. XEBDC-02EU-D
controlled only by the oven's
control Panel
860 x 1150 x 400 mm - w x d x h
Art. XEBDC-02EU-C

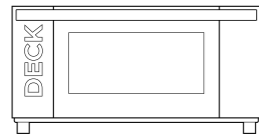

DECKTOP 1 TRAY

with integrated control
860 x 880 x 400 mm - w x d x h
Art. XEBDC-01EU-D
controlled only by the oven's
control Panel
860 x 880 x 400 mm - w x d x h
Art. XEBDC-01EU-C

BASKETS AND TROLLEY

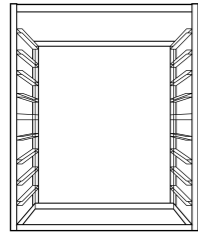

BASKET

for COUNTERTOP ovens
10 600 x 400
668 x 431 x 862 mm - w x d x h
Art. XWBBC-10EU

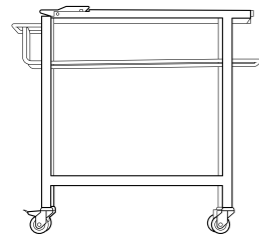

TROLLEY

for XWBBC-10EU basket
695 x 786 x 961 mm - w x d x h
Art. XWBYC-00EU

CONNECTION

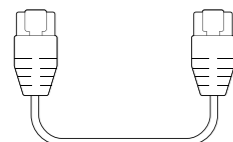

ACCESSORIES FOR THE OVENS CONNECTION

Ethernet connection kit
Art. XEC001

PROVERS

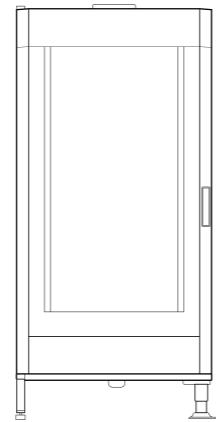

LIEVOX

with integrated control
16 600 x 400
866 x 950 x 1879 mm - w x d x h
Art. XEBPL-16EU-D
with manual control
16 600 x 400
866 x 950 x 1879 mm - w x d x h
Art. XEBPL-16EU-M

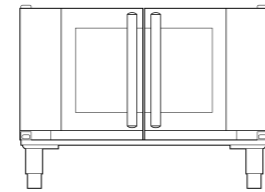

LIEVOX

12 600 x 400
860 x 978 x 798 mm - w x d x h
Art. XEBPC-12EU-B
8 600 x 400
860 x 978 x 658 mm - w x d x h
Art. XEBPC-08EU-B

NEUTRAL CABINET

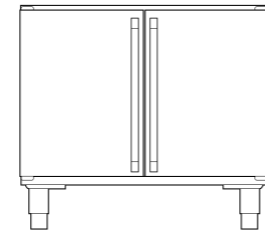

NEUTRAL CABINET

for 600 x 400 COUNTERTOP ovens
860 x 860 x 720 mm - w x d x h
Art. XWAEC-08EF

STEAM.BOOST

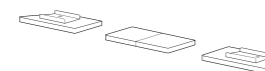

STEAM.BOOST

increases steam production
by 45% for 2 minutes
Art. XUC080
Art. XUC081
Art. XUC082

STAND

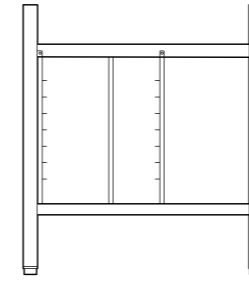

ULTRA HIGH STAND

for 600 x 400 COUNTERTOP ovens
842 x 804 x 888 mm - w x d x h
Art. XWARC-07EF-UH

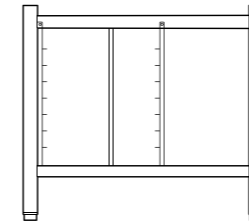

HIGH STAND

for 600 x 400 COUNTERTOP ovens
842 x 713 x 752 mm - w x d x h
Art. XWARC-07EF-H

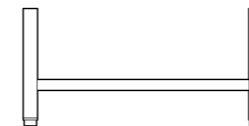

INTERMEDIATE STAND

for 600 x 400 COUNTERTOP ovens
842 x 713 x 462 mm - w x d x h
Art. XWARC-00EF-M



LOW STAND

for 600 x 400 COUNTERTOP ovens
842 x 713 x 305 mm - w x d x h
Art. XWARC-00EF-L

FLOOR POSITIONING



* Mandatory for oven
positioning on the floor

FLOOR POSITIONING

for 600 x 400 COUNTERTOP ovens
842 x 713 x 113 mm - w x d x h
Art. XWARC-00EF-F

QUICK.LOAD

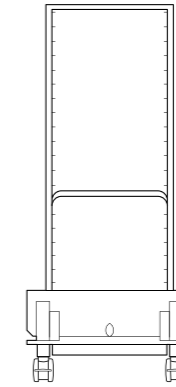

QUICK.LOAD

for 16 600 x 400 BIG ovens
776 x 681 x 1741 mm - w x d x h
Art. XEBTL-16EU
For the suggested solutions see
page 40

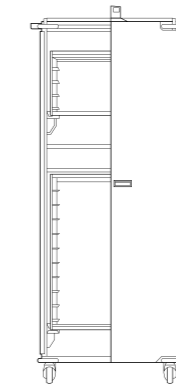

QUICK.LOAD 10 + 4

without doors
14 600 x 400
768 x 539 x 1920 mm - w x d x h
Art. XWBYC-14EU
with doors
14 600 x 400
768 x 539 x 1920 mm - w x d x h
Art. XWBYC-14EU-D
For the suggested solutions see
page 40

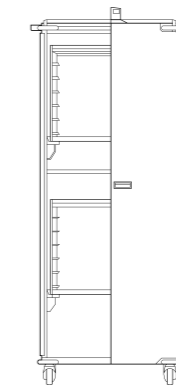

QUICK.LOAD 6 + 6

without doors
12 600 x 400
768 x 539 x 1920 mm - w x d x h
Art. XWBYC-12EU
with doors
12 600 x 400
768 x 539 x 1920 mm - w x d x h
Art. XWBYC-12EU-D
For the suggested solutions see
page 40

WHEELS KIT

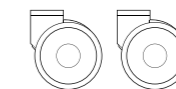

WHEELS KIT

2 wheels with brake - 2 wheels
without brake - safety chains
Art. XUC012

Technical Assistance

Installation

The right partner next to your kitchen

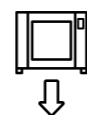

A global Service network

A perfect installation is essential to guarantee the correct functioning of your MIND.Maps™ PLUS oven and eliminate interruptions in your daily work. We focus on you, so you can focus on what matters to you. Find the authorized Service Centers nearest to your kitchen.

Maintenance

Don't stop your kitchen



The quickest on site Service

When connected to the internet, your oven communicates directly with our Service Team, so we can intervene as soon or even before maintenance is required. Keeping in optimal condition your oven is Unox' priority: our technicians are at your disposal to provide you the best on-line and on-site support.

LONG.Life and LONG.Life4 Warranty

A promise of reliability



A choice made to last

Connect your BAKERTOP MIND.Maps™ PLUS to the internet and activate the Unox LONG.Life4 extended warranty on our website unox.com. Up to 4 years / 10.000 working hours, whichever occurs first, on parts and 2 years on labor.*

*Check the Guarantee Conditions for your country on our website unox.com

LONGLife4!

Global Company. Best Services worldwide.

Unox in the world

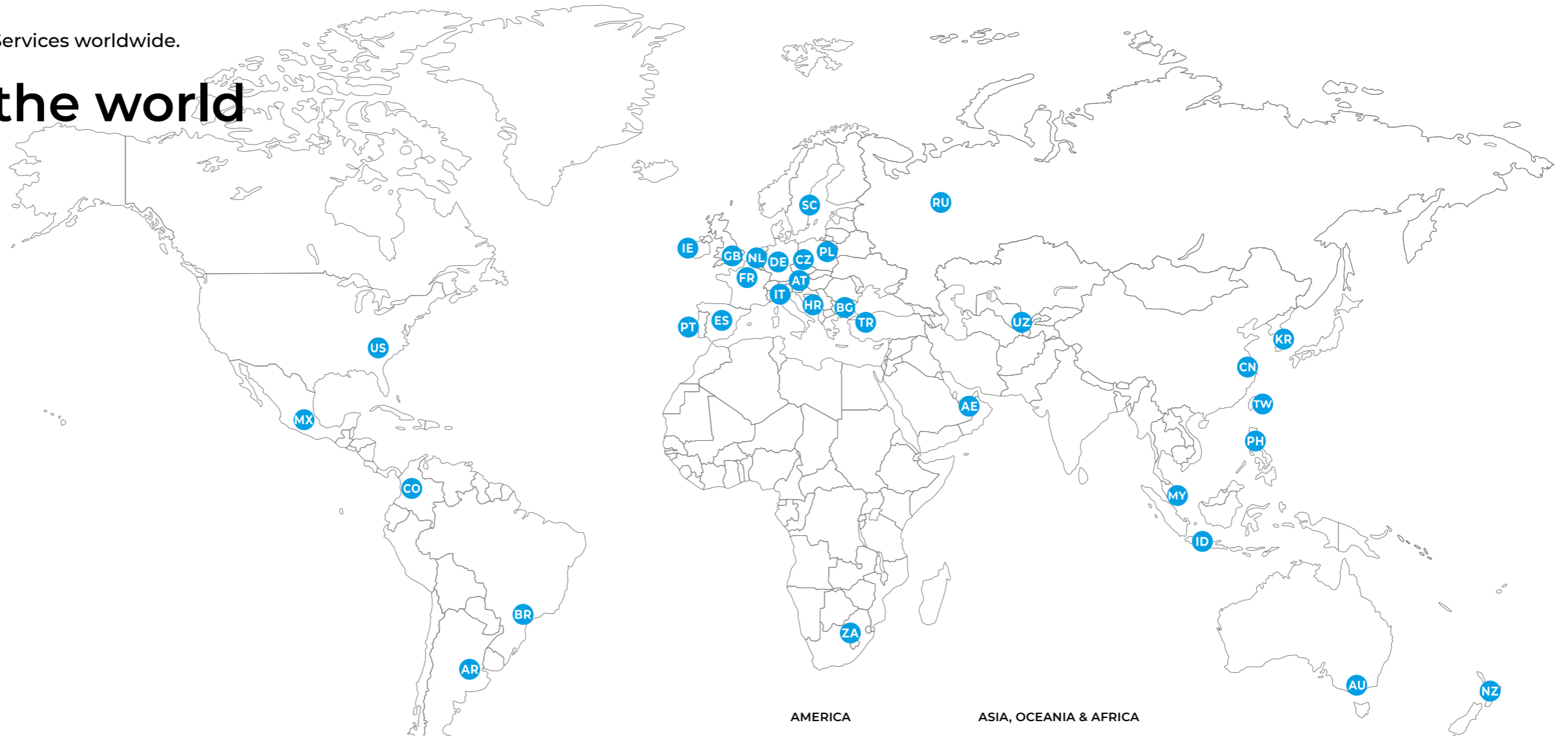

INTERNATIONAL

UNOX S.p.a
Via Majorana, 22
35010 - Cadoneghe (PD) - Italy
E-mail: info@unox.com
Tel: +39 049 8657511

EUROPE

IT - ITALIA
UNOX S.p.a
E-mail: info@unox.it
Tel: +39 049 8657511

DE - DEUTSCHLAND
UNOX DEUTSCHLAND GMBH
E-mail: info.de@unox.com
Tel: +49 2951 98760

FR - FRANCE, BELGIUM & LUXEMBOURG
UNOX FRANCE s.a.s.
E-mail: info.fr@unox.com
Tel: +33 4 78 17 35 39

PT - PORTUGAL
UNOX PORTUGAL
E-mail: info.pt@unox.com
Tel: +351 918 228 787

ES - ESPAÑA
UNOX PROFESIONAL ESPAÑA S.L.
E-mail: info.es@unox.com
Tel: +34 900 82 89 43

GB - UNITED KINGDOM
UNOX UK Ltd.
E-mail: info@unoxuk.com
Tel: +44 1252 851 522

IE - IRELAND
UNOX IRELAND
E-mail: info.ie@unox.com
Tel: +353 (0) 87 32 23 218

SC - SCANDINAVIAN COUNTRIES
UNOX SCANDINAVIA AB
E-mail: info.se@unox.com
Tel: +46(0)790 75 63 64

AT - ÖSTERREICH
UNOX ÖSTERREICH GMBH
E-mail: bestellung@unox.com
Tel: +43 800 880 963

RU - РОССИЯ, ПРИБАЛТИКА И СТРАНЫ СНГ
UNOX РОССИЯ
E-mail: info.ru@unox.com
Tel: +7 (499) 702 - 00 - 14

CZ - ČESKÁ REPUBLIKA
UNOX DISTRIBUTION s.r.o.
E-mail: info.cz@unox.com
Tel: +420 241 940 000

HR - HRVATSKA
UNOX CROATIA
E-mail: narudzbe@unox.com
Tel: +39 049 86 57 538

BG - БЪЛГАРИЯ
UNOX BULGARIA
E-mail: info.bg@unox.com
Tel: +359 2 419 05 00

PL - POLSKA
Unox Polska Sp.zo.o.
E-mail: info.pl@unox.com
Tel: +48 665 232 000

TR - TÜRKİYE - UNOX TURKEY
Profesyonel mutfak ekipmanlari endüstri ve ticaret limited şirketi
E-mail: info.tr@unox.com
Tel: +90 530 176 62 03

NL - NETHERLANDS
UNOX NETHERLANDS B.V.
E-mail: info.nl@unox.com
Tel: +31 6 27 21 14 10

AMERICA

US - U.S.A. & CANADA
UNOX Inc.
E-mail: info.usa@unox.com
Tel: +1 800 489 8669

CO - COLOMBIA
UNOX COLOMBIA
E-mail: info.co@unox.com
Tel: +57 350 65 88 204

BR - UNOX BRASIL
SERVICOS LTDA.
E-mail: info.br@unox.com
Tel: +55 11 98717-8201

AR - ARGENTINA
UNOX ARGENTINA
E-mail: info.ar@unox.com
Tel: +54 911 37 58 43 46

MX - MEXICO
UNOX MEXICO, S. DE R.L. DE C.V.
E-mail: info.mx@unox.com
Tel: +52 55 8116-7720

ASIA, OCEANIA & AFRICA

ZA - SOUTH AFRICA
UNOX SOUTH AFRICA
E-mail: info.sa@unox.com
Tel: +27 845 05 52 35

AE - U.A.E.
UNOX MIDDLE EAST DMCC
E-mail: info.uae@unox.com
Tel: +971 4 554 2146

UZ - UZBEKISTAN
UNOX PRO LLC
E-mail: info.uz@unox.com
Tel: +998 90 370 90 10

CN - 中华人民共和国
UNOX TRADING (SHANGHAI) Ltd. CO.
电子邮件: info.china@unox.com
电话: +86 21 56907696

MY - MALAYSIA & SINGAPORE
UNOX (ASIA) SDN. BHD
E-mail: info.asia@unox.com
Tel: +603-58797700

PH - PHILIPPINES
UNOX PHILIPPINES
E-mail: info.asia@unox.com
Tel: +63 9173108084

ID - INDONESIA
UNOX INDONESIA
E-mail: info.asia@unox.com
Tel: +62 81908852999

KR - 대한민국
UNOX KOREA CO. Ltd.
이메일: info.asia@unox.com
전화: +82 2 69410351

TW - TAIWAN, HONG KONG & MACAU
UNOX TAIWAN
E-mail: info.tw@unox.com
Tel: +886 928 250 536

AC - OTHER ASIAN COUNTRIES
UNOX (ASIA) SDN. BHD
E-mail: info.asia@unox.com
Tel: +603-58797700

AU - AUSTRALIA
UNOX AUSTRALIA PTY Ltd.
E-mail: info@unoxaustralia.com.au
Tel: +61 3 9876 0803

NZ - NEW ZEALAND
UNOX NEW ZEALAND Ltd.
E-mail: info@unox.co.nz
Tel: +64 (0) 800 76 0803



INVENTIVE SIMPLIFICATION

unox.com



LI1392B0 printed on 01-2020

All images used are for illustrative purposes only.

All features indicated in this catalogue may be subject to change and could be updated without notice.